



AUDIORAQ®

AUDIOLAB®

ERARD®
PRO



Barkan 
a better point of view™



hager

Rednerpulte/Stelen
Leggii/Totem Display Stand
Pupitre de conférence/ Totem Display Stand

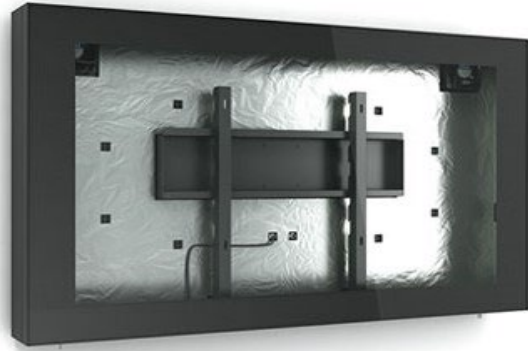

Leinwände und Zubehör
Schermi e accessori
Écrans de projection et accessoires

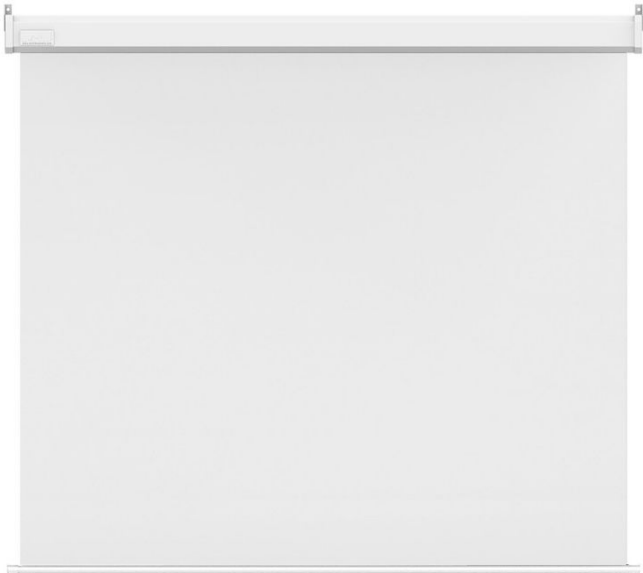
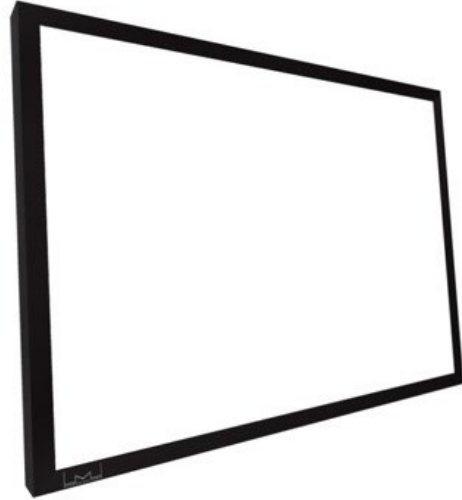
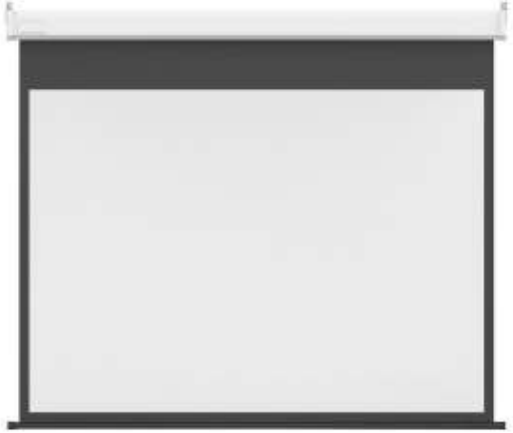

Elektrische und manuelle Whiteboard Halter
Supporti per lavagne elettriche e manuali
Supports pour tableaux blancs électriques et manuels

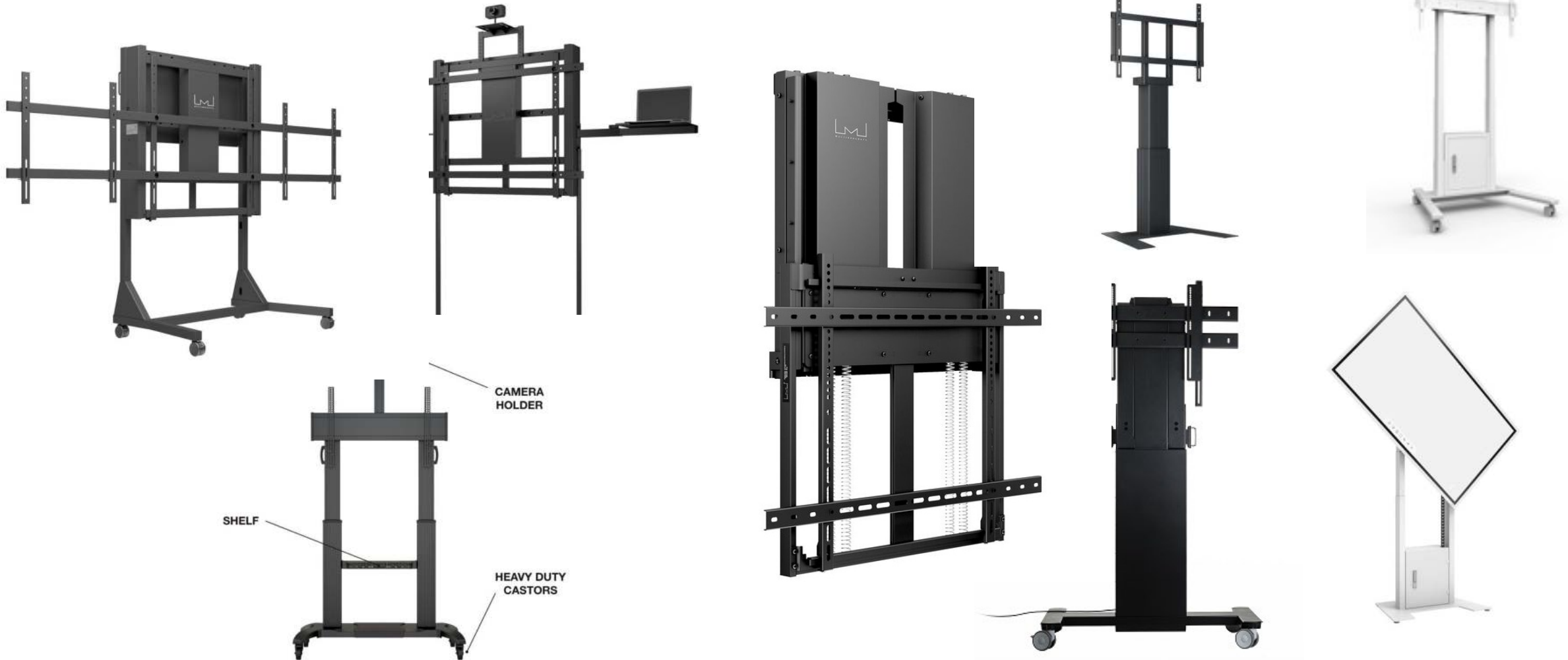

Desktop Halterungen aller Art
Supporti da tavolo di tutti i tipi
Supports de bureau de tous types



TV Lift Systeme
Systemi di sollevamento per TV
Systèmes de levage pour TV

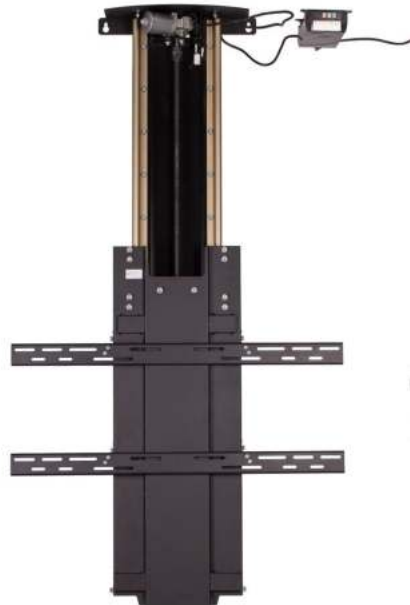

Beamer Halterungen/Liftsysteme
Supporti per proiettori / sistemi di sollevamento
Supports/systèmes de levage pour vidéoprojecteurs





Medizinalbereich
Settore medicale
Secteur médical



Installationskabel Audio/Video/AC Cavi di installazione audio/video/AC Câble d'installation audio/vidéo/AC



- Beispiel:
1. Kindermann Blende Edizio HDMI (Kabelpeitsche)
 2. Kindermann Blende Edizio Cat-6/6A (LSA)
 3. Kindermann Montagerahmen Edizio 1fach
 4. Edizio Rahmen

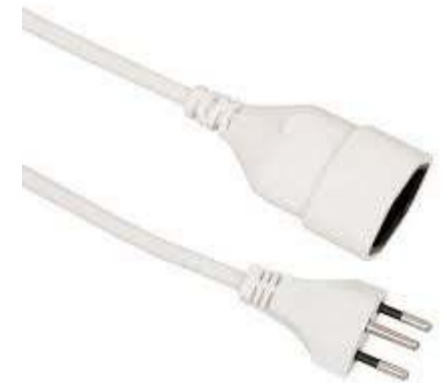
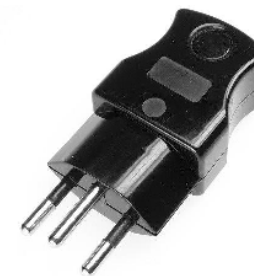

Kabel Management

Gestione dei cavi

Gestion des câbles

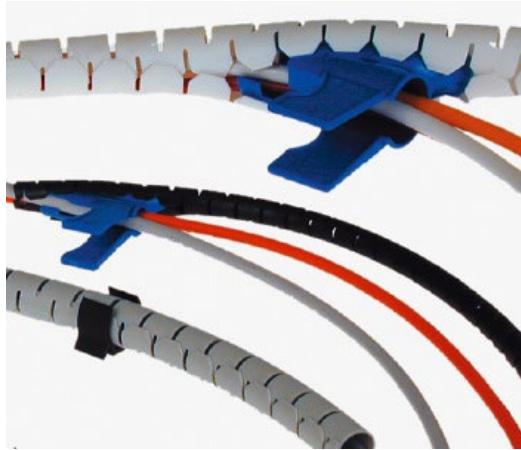

Zubehör Accessori Accessoires

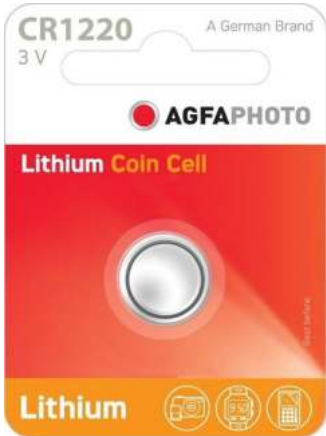



Projekte Progetti Projects





Projekte Progetti Projects

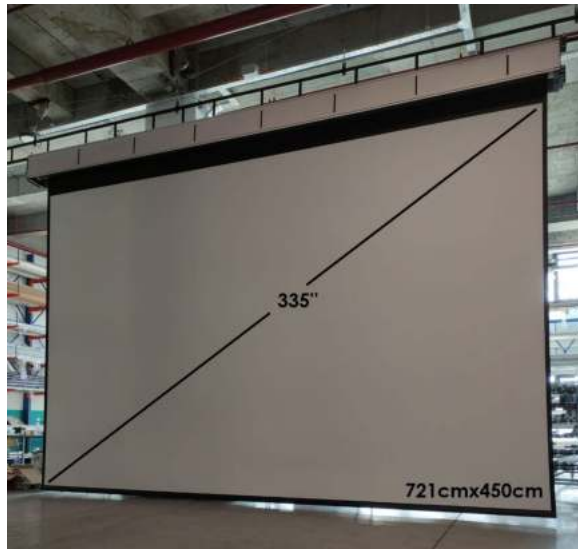

Vielen Dank für das Interesse!
Grazie per il vostro interesse!
Merci beaucoup de votre intérêt !

Wir stehen für Fragen und Antworten immer bereit:

Siamo sempre a disposizione per domande e risposte:

Nous sommes toujours prêts à répondre à vos questions :

HOTLINE:

Ali Yasar Geschäftsführer CEO Mobile 079 176 00 18

Ivan Cibola Verkaufsleiter VKL Mobile 079 660 56 57

Büro : 055 442 35 45

Email: info@guntlin.ch